

Implantable Fluid Energy Harvester 生体植込み可能な流体振動発電素子

Satoshi Inoue, Takuya Takahashi, Momoko Kumemura,
Hiroyuki Fujita, and Hiroshi Toshiyoshi

Implantable energy harvester can generate enough power of 1 mW from heart motion to drive less-invasive respiratory device. Using an external pump instead of heart motion, the capacitance difference of fabricated channel filled with air and de-ionized water is 5.5 nF. In addition, the simulation result shows 8 μ F capacitance difference caused by 20 V_{p-p} amplitude and 2.7 μ W average power.

Introduction

Synapse Biomedical Inc. developed less-invasive respiration method for ALS (Amyotrophic Lateral Sclerosis) patients and in this work we will fabricate implantable fluid energy harvester which generates 1 mW to drive the system.

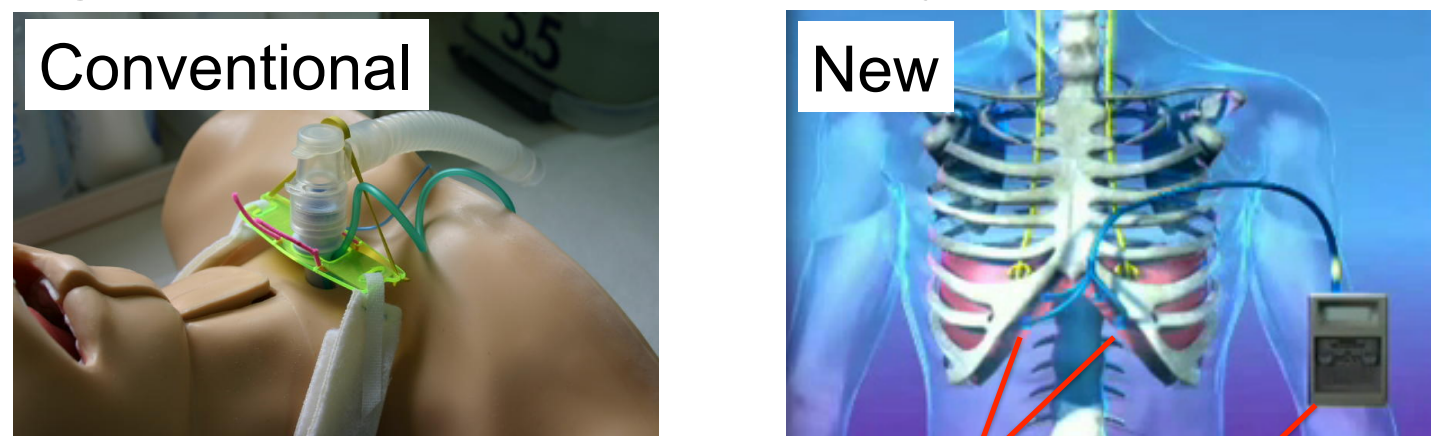

✗ Painful
✗ Difficult to speak

Diaphragm
Pulse generator

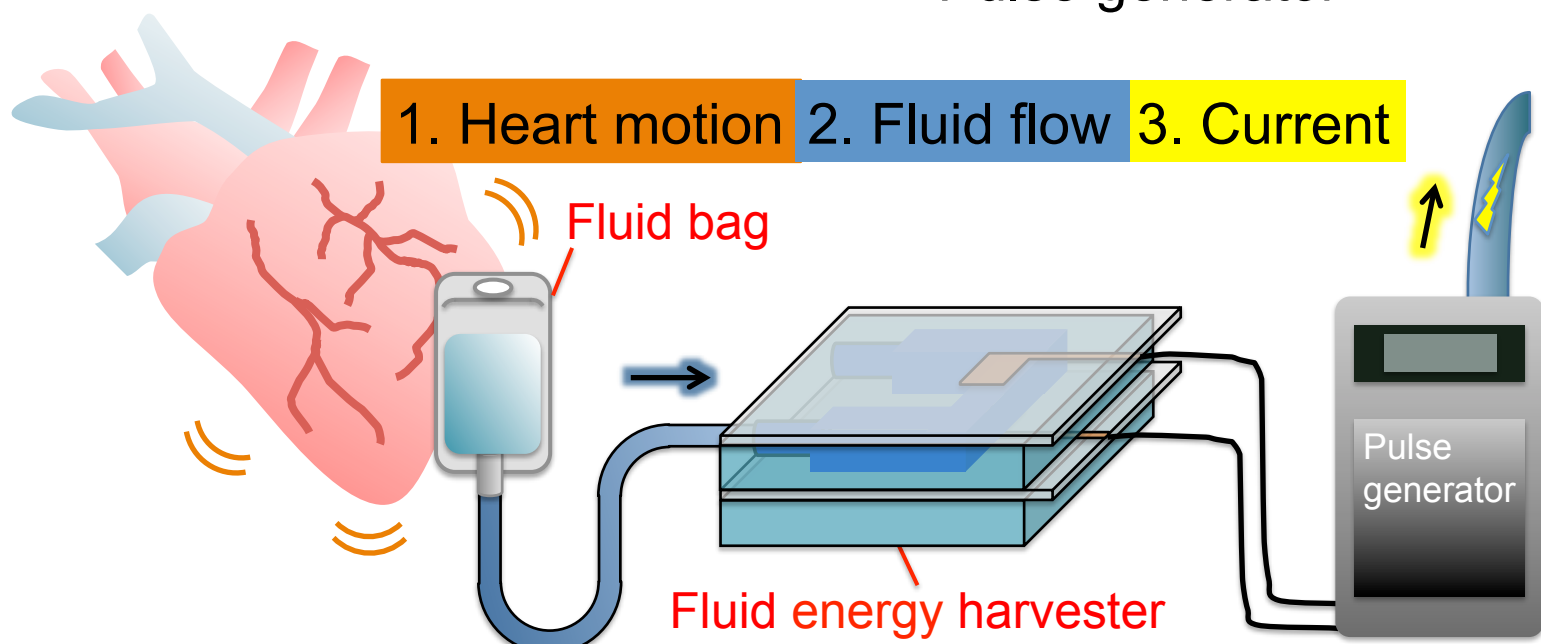

Mechanism to Generate Power

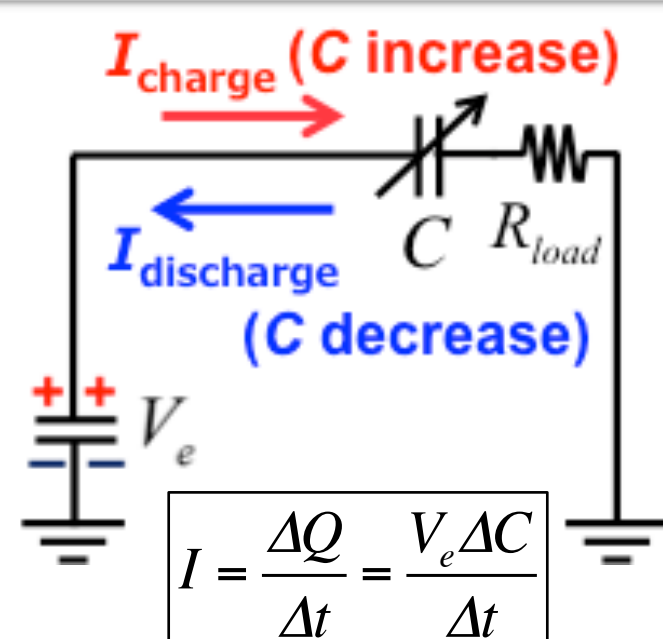
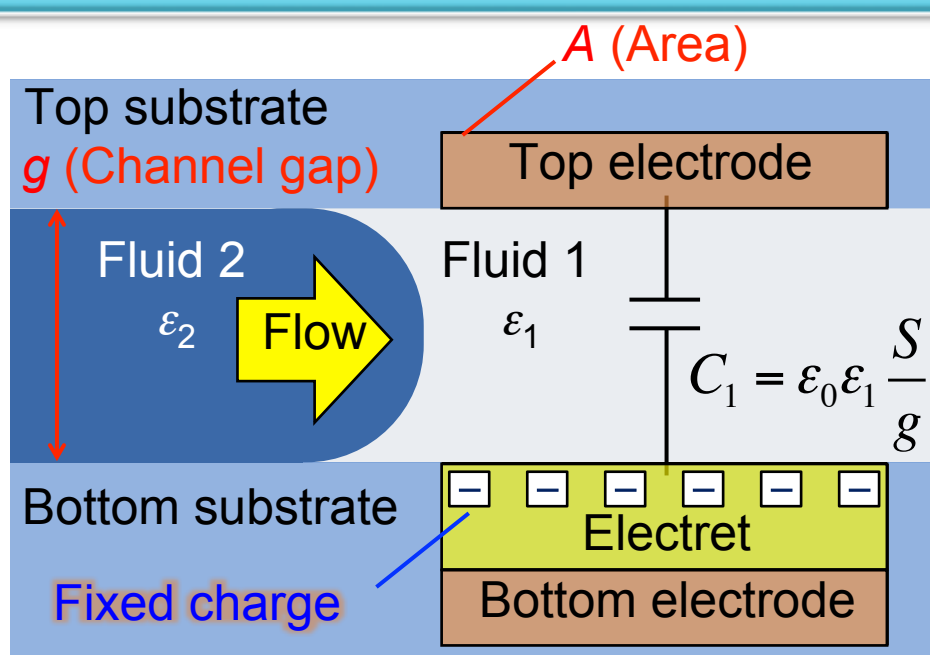

Fluid Energy Harvester is composed of micro-channel with electrode and electret which is a dielectric with semi-permanent fixed charge. When the fluid is driven, the capacitance changes and that causes current flow.

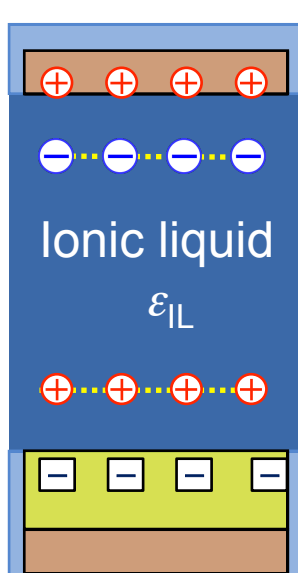

Ionic liquid forms electrical double layer between the channel which makes the gap so shorter that the device will generate huge ΔC and larger current.

※ Ionic liquid : a salt in liquid state

Fabrication and Measurement

The channel is composed of two glass substrates on which Al was deposited as electrodes, and rubber sheet with two holes to insert a tube. While de ionized water was flowing the channel continuously by a syringe pump, the channel capacitance was measured by LCR meter.

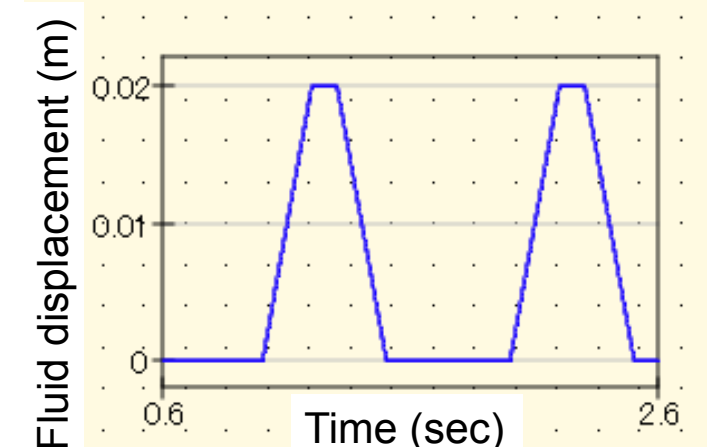
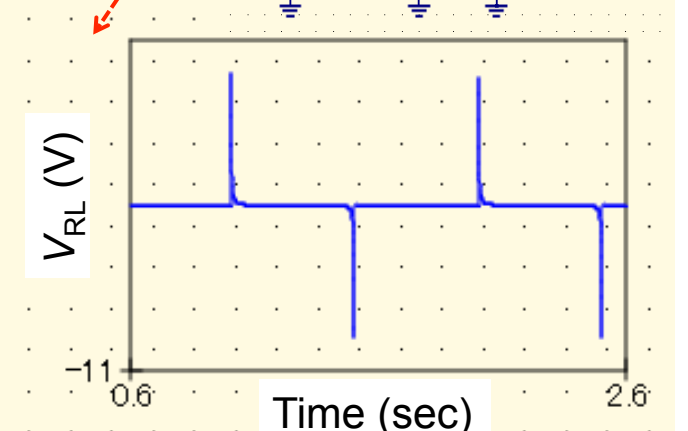
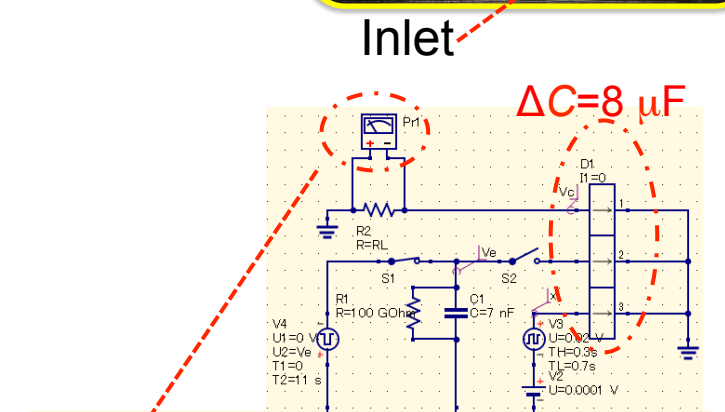
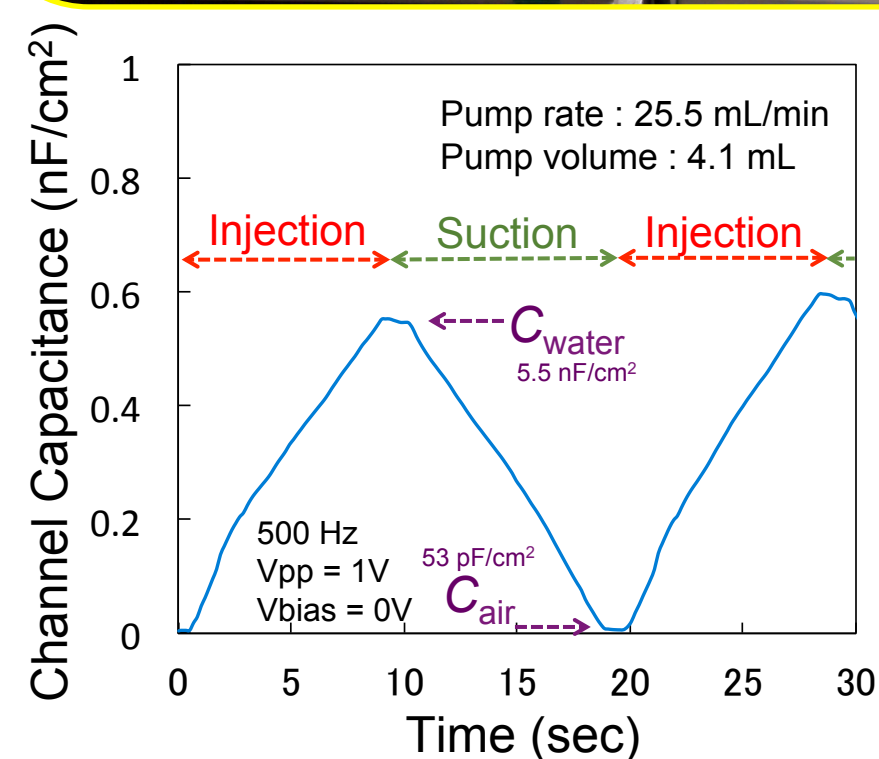
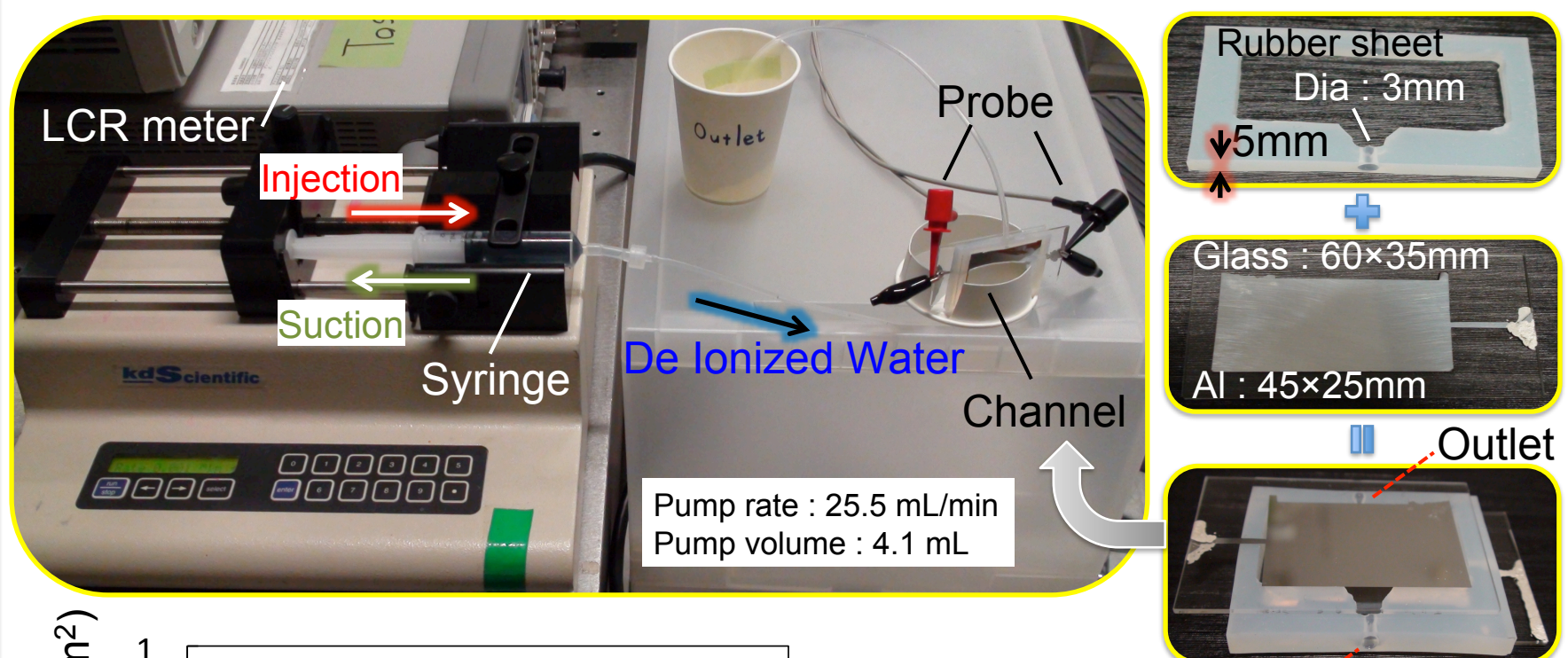

As a result, we verified the capacitance change by driving the flow.

Besides, we analyzed equivalent circuit model with the simulator, Qucs. The result showed pulse shape ionic liquid displacement induced 20 V_{peak-peak}, and that generated 2.7 μ W.

Conclusion and Future Works

The difference in channel capacitance has been studied due to the flow of de-ionized water through the channel, in consequence it caused current flow, which lead to power generation theoretically. In future, we are targeting to generate 1 mW of power with ionic liquid flow. Also replacing glass substrate and Al electrode with PDMS and Au to make the device biocompatible.

Contact: inosato@iis.u-tokyo.ac.jp